

***kuraray***

**December 17, 2024**

# **Kuraray Management Briefing**

**KURARAY CO., LTD.**

# Today's Theme

**Growth opportunities for  
Genestar™**

**Hitoshi Kawahara**

President and Representative Director

**Yoji Ikemori**

Managing Executive Officer

President of Isoprene Company and

General Manager of Genestar Division

# Growth opportunities for Genestar™



# Overview of Isoprene Company

# Overview of Isoprene Company Business

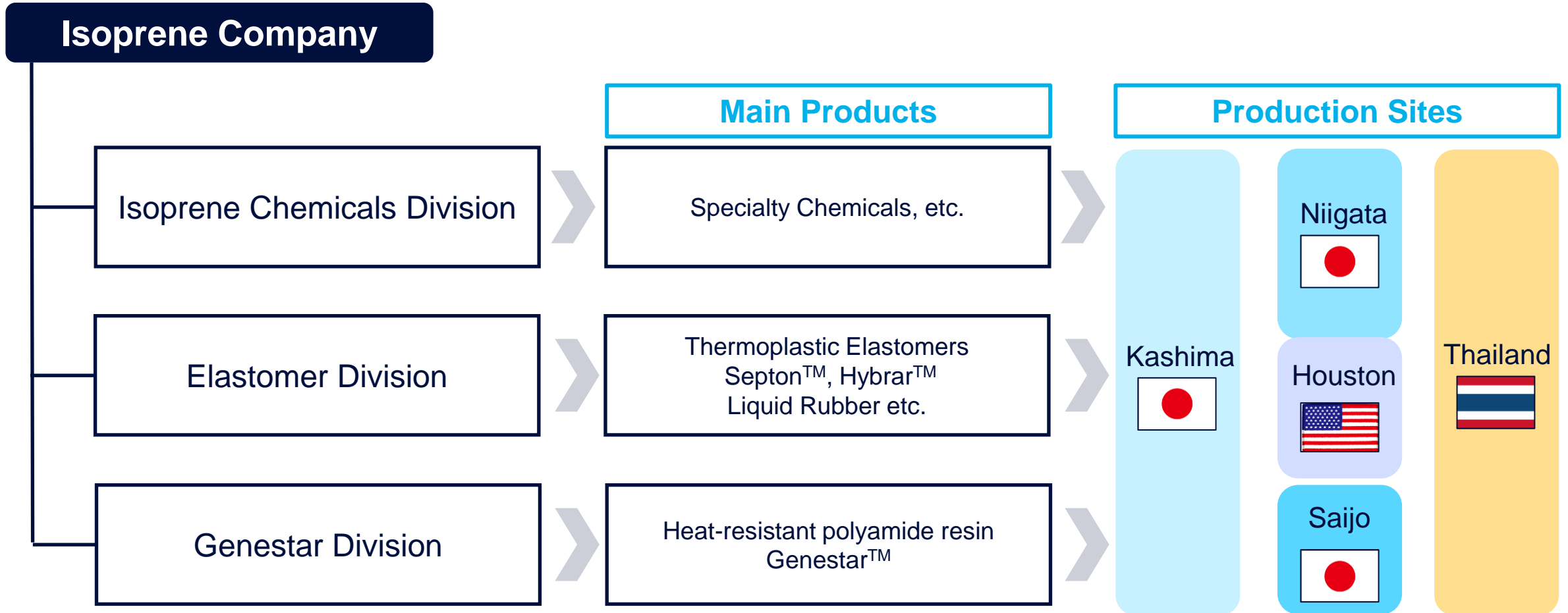

**Business development using C4 fractions  
(butadiene and isobutylene) as raw materials**

# Overview of Production Site in Thailand

<b>Place</b>	<b>: Map Ta Phut, Rayong Province, Thailand (WHA Eastern Industrial Estate within the petrochemical complex)</b>
<b>Start of operation</b>	<b>: In stages from February 2023</b>
<b>Production Capacity</b>	<b>: Kuraray Advanced Chemicals(Thailand) Isobutylene derivative MPD (production capacity: 5,000t/y) : Kuraray GC Advanced Materials Hydrogenated styrenic block copolymer Septon™ (production capacity 16,000t/y) Heat-resistant polyamide resin Genestar™ (production capacity 13,000t/y)</b>
<b>Investment amount</b>	<b>: Approx. 60 billion JPY (Kuraray's expense: approx. 40 billion JPY)</b>

※Calculated using the exchange rate as of the date of the investment decision, December 26, 2018)

【New Production Site in Thailand】

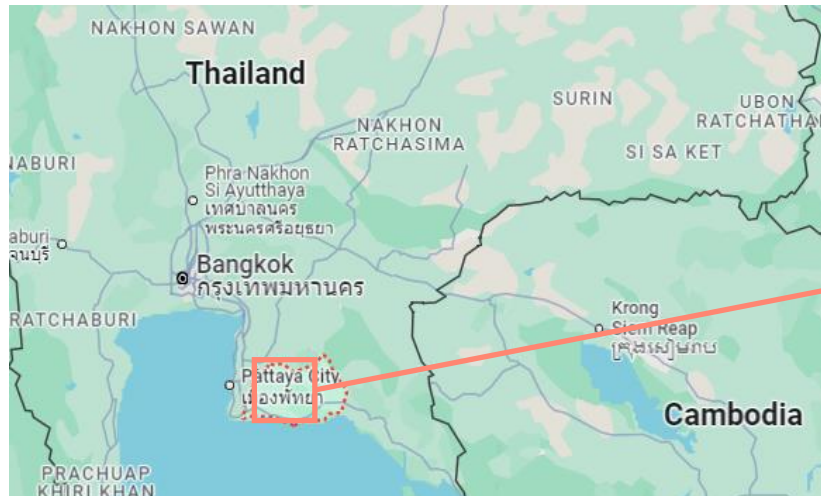

# Thailand Business Scheme

**GC\*1**

Brand strength in Thailand/Southeast Asia

**GC  
PTT Group**

**Butadiene**

**Utilities, etc.**

**Isobutylene**

**Kuraray**

Production technology, R&D and marketing capabilities

**Sumitomo Corporation**

Global sales channel

**Kuraray GC Advanced Materials**  
Kuraray (53.3%), GC (33.4%), Sumitomo Corporation (13.3%)

Genestar™ Production capacity 13,000 t/y

Septon™ Production capacity 16,000 t/y

**Kuraray Advanced Chemicals (Thailand)**  
Kuraray (100%)

MPD Production capacity 5,000 t/y

## Global business expansion

\*1 PTT Global Chemical Public Company Ltd.

\*2 The numbers in parentheses indicate investment ratios.



# Growth Opportunities for Genestar™



# What is Genestar™?

- Heat-resistant polyamide resin (PA9T) developed from Kuraray's unique monomer

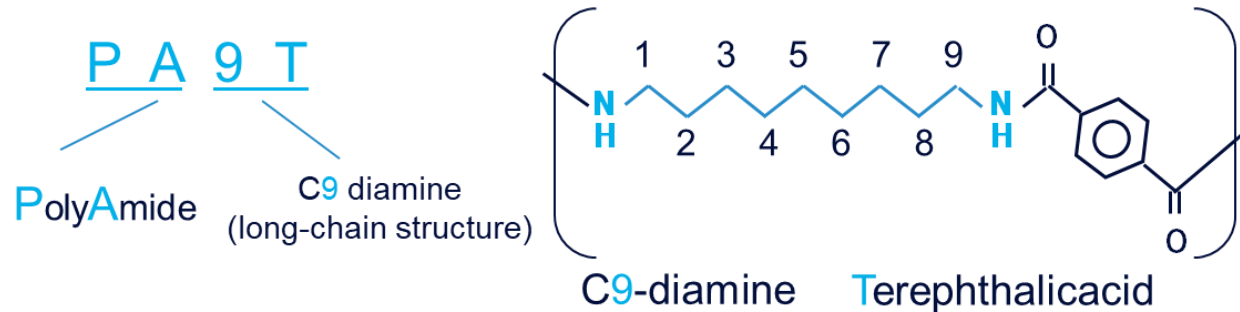

- Adoption of Genestar™ is expanding across various fields due to its well-balanced high physical properties, such as strength, heat resistance, and abrasion resistance.
- Exhibits the lowest level of water absorption among heat-resistant polyamides.

## 【Genestar™ Comparison with Competitive Resins】

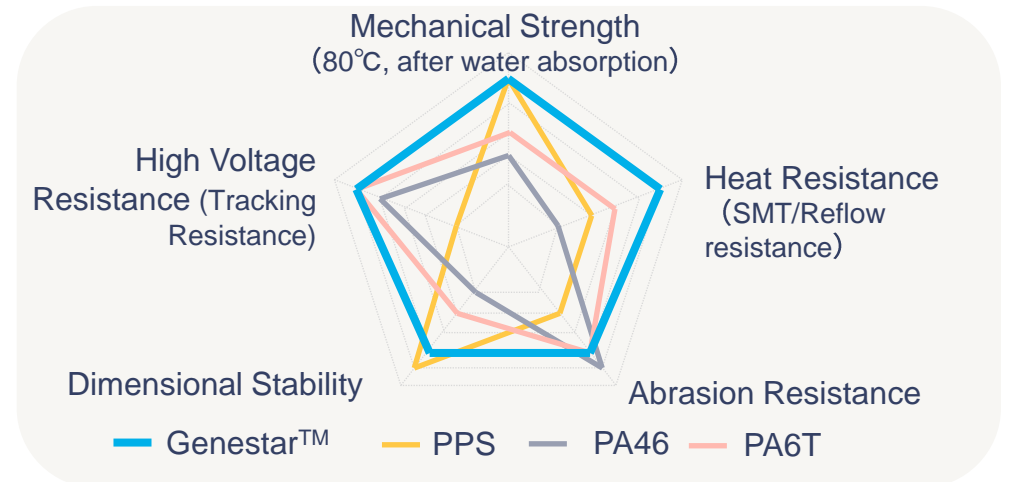

**Genestar™ shows well-balanced property**

## 【Polyamide Resin Water Absorption Comparison】

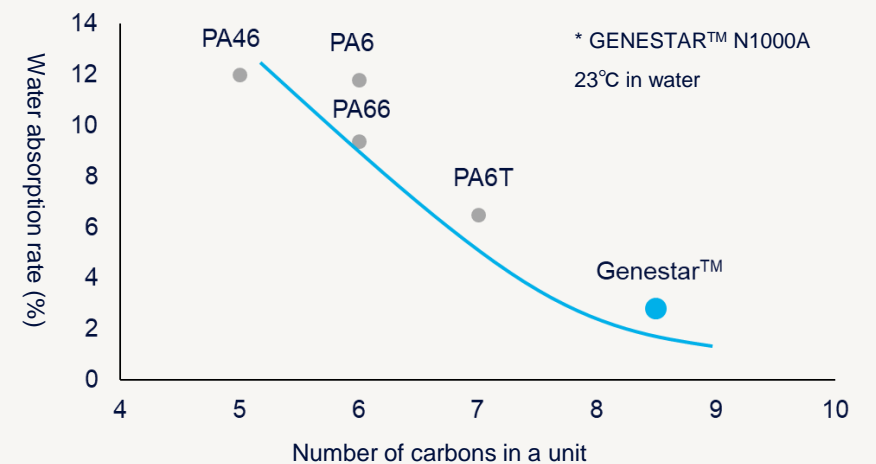

# Sales & Marketing and Technical Service Network

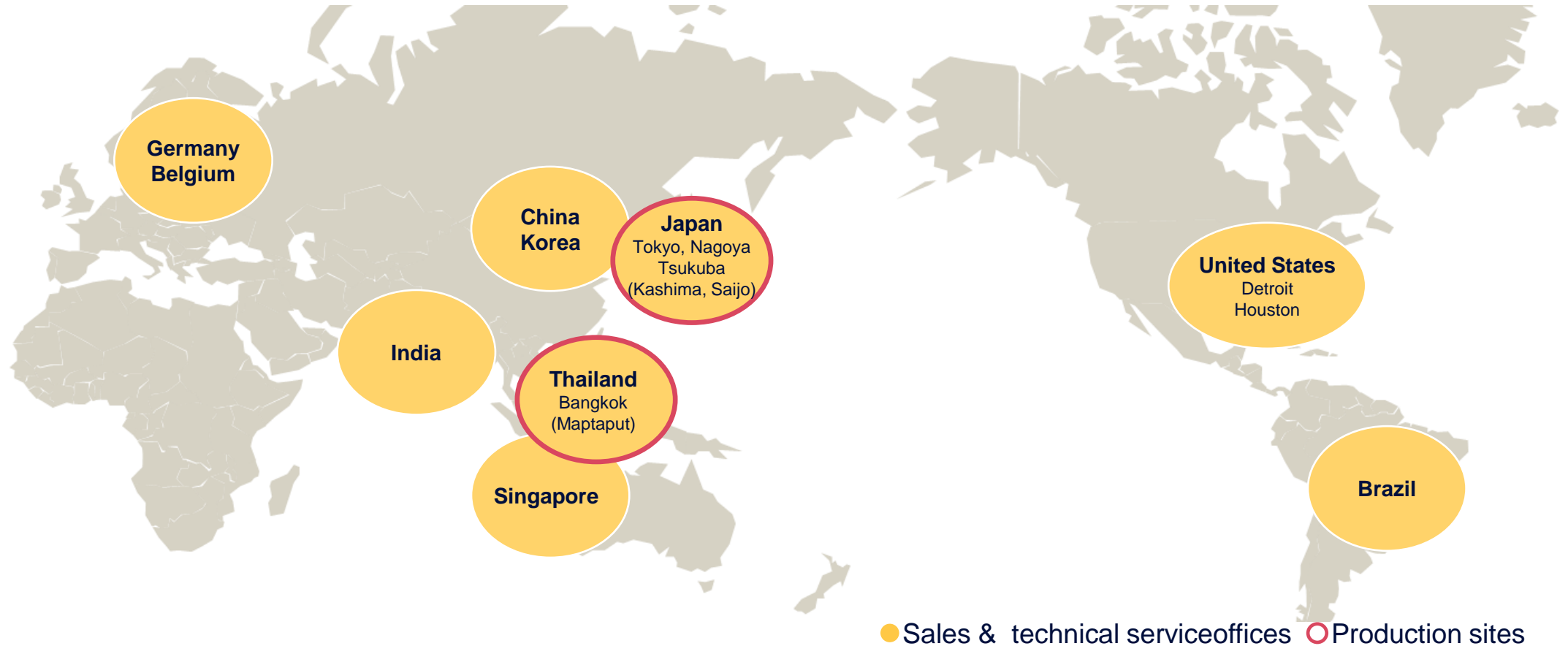

- Established a BCP system by operating production at two locations in Japan and one location in Thailand
- Accelerating global expansion by leveraging our global network of **13 locations in 10 countries**

# Genestar™ Application Examples

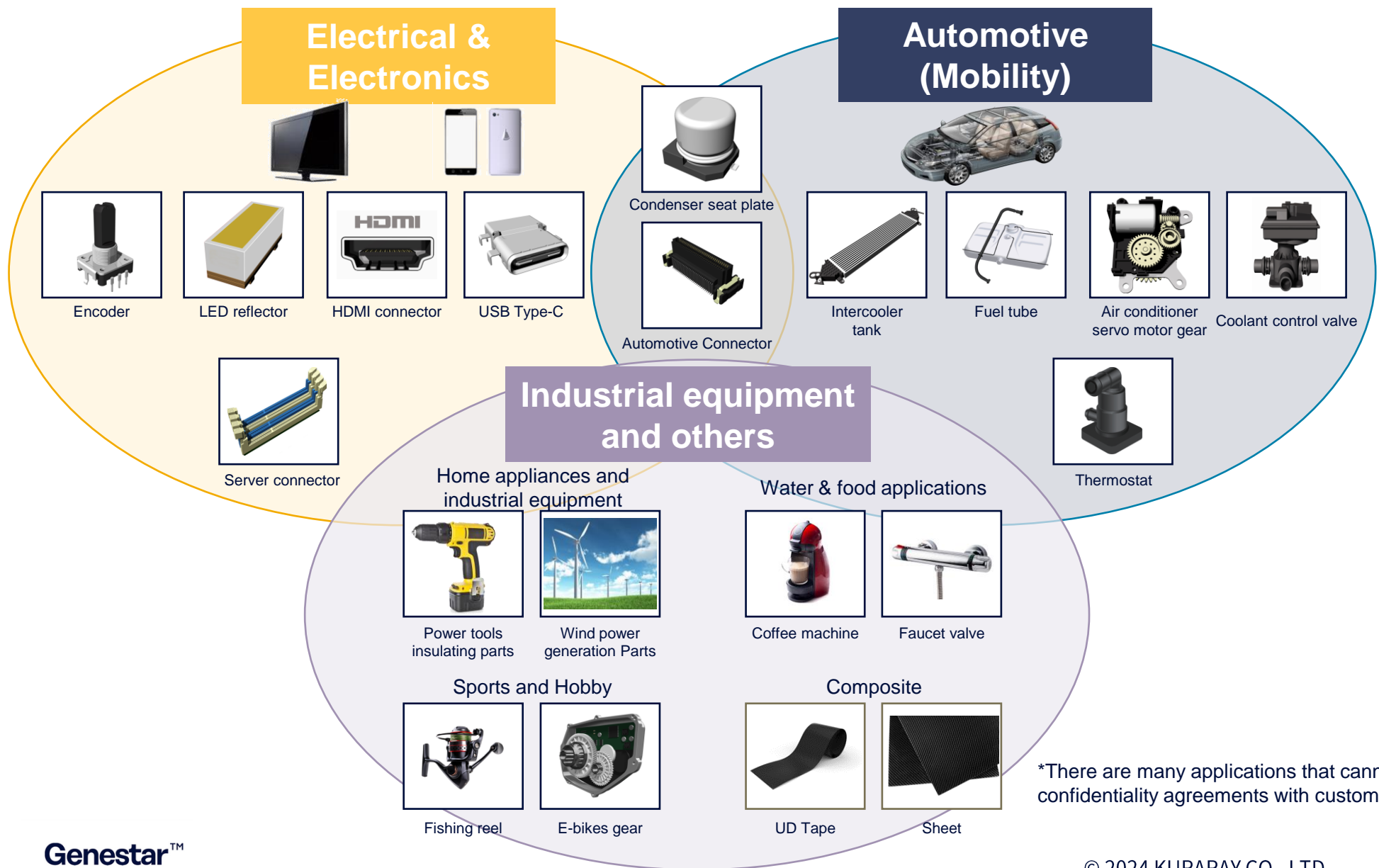

\*There are many applications that cannot be disclosed due to confidentiality agreements with customers.

# Market Trends and Market Development of Genestar™

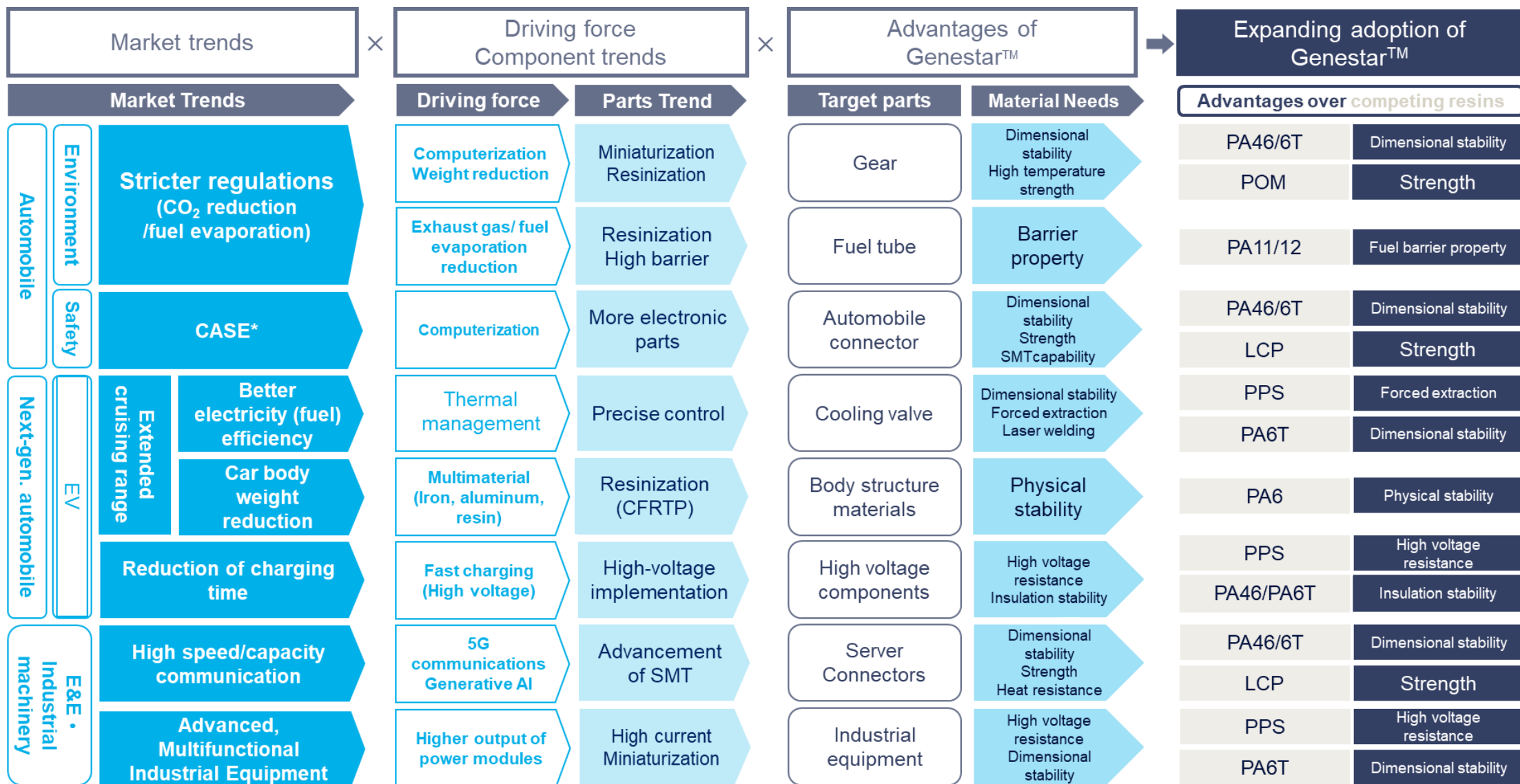

\*CASE : Connected, Autonomous, Shared, and Electric

# Mobility① Thermal Management Components

**Market Trends**

Better electricity (fuel) efficiency  
(Extension of cruising range)

**Driving Force**

Thermal management

**Parts Trend**

Precise control

**Material Needs**

Dimensional stability  
Forced extraction  
Laser welding

- Increasing number of thermal management components for more efficient thermal management to extend cruising range
- Progress in the use of plastic parts for weight reduction of car body
- Expanding adoption by leveraging Genestar™'s dimensional stability, strength and laser transparency

【ICE Vehicle Thermal Management Components】

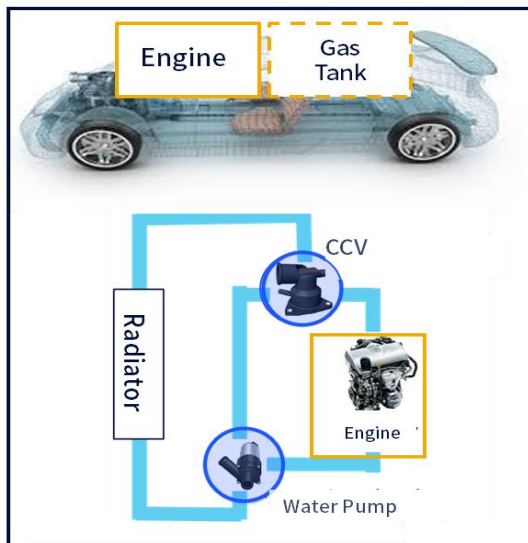

※CCV : Coolant Control Valve

【BEV/HEV Thermal Management Components】

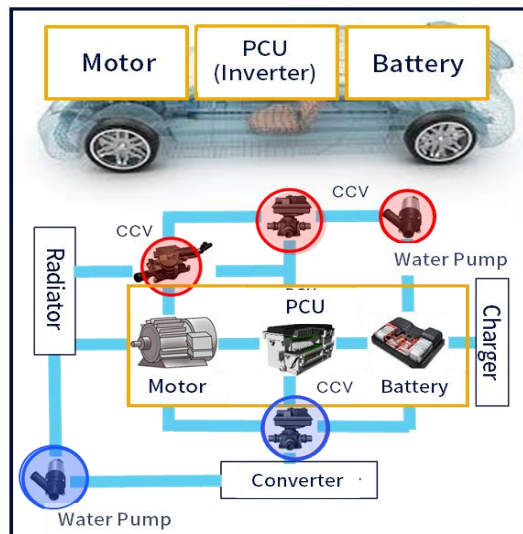

○ Thermal management parts to increase with EVs (PA9T target parts)

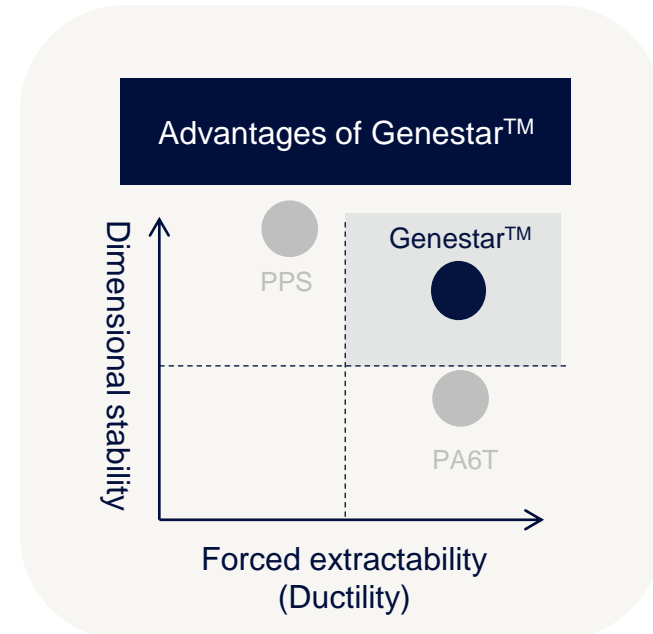

# Mobility ② Gear Parts for Automobile and Other Uses

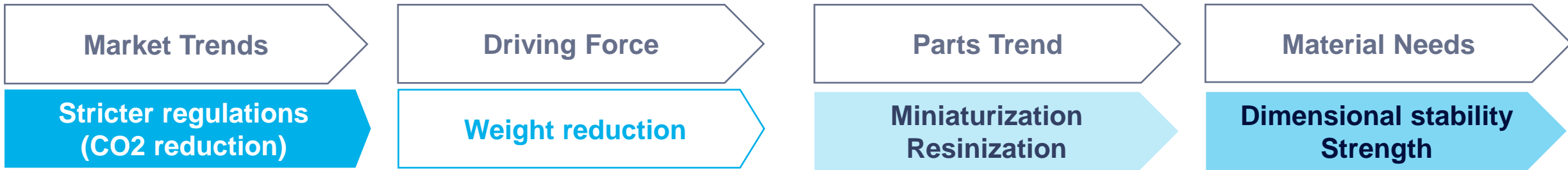

- Progress in vehicle weight reduction through **miniaturization and resinization** to comply with stricter CO2 emission regulations.
- Increase in **gear parts** due to the advancement of functionality and electronic control of vehicles
- **Miniaturization and resinization** of gears by leveraging **Genestar™'s dimensional stability and strength**.

Miniaturization of gears for HVAC system

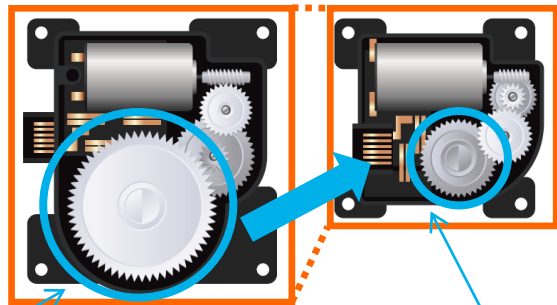

(Conventional)  
General-engineering plastics  
Insufficient strength.  
Difficult to miniaturize gears

(Miniaturization)  
By Genestar™  
40% smaller  
component by gear  
miniaturization

Headlamp actuator gear

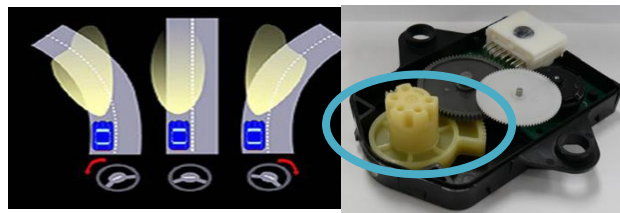

Located directly under the heat-generating headlamps, requiring **heat resistance and strength in high-temperature environments exceeding 100°C**

\*Headlamp actuator  
Improves visibility during cornering by directing light towards the steering direction. Increasingly common in general vehicles.

Advantages of Genestar™

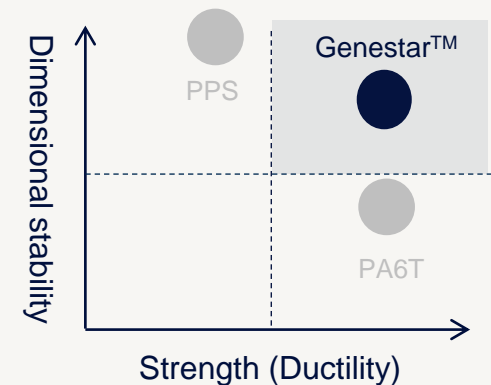



# Mobility ③ Fuel Tube for Automobiles and Other Uses

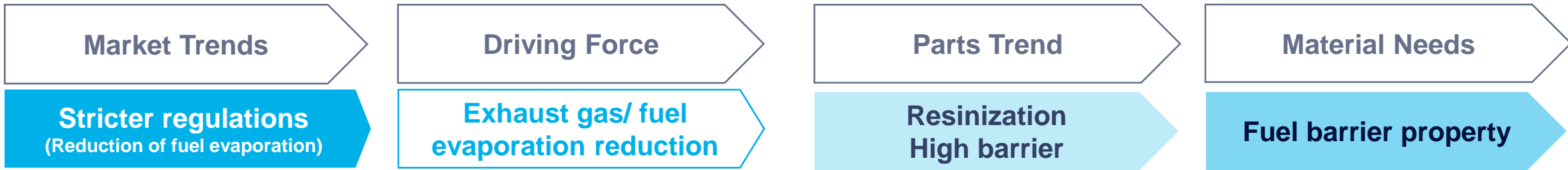

- Increasing need for fuel line **barriers** due to further stricter emission regulations
- Adoption of **Genestar™** is expanding due to its high **fuel barrier** property
- **Extrusion moldability + high barrier** material characteristics have led to increasing use in various tube/pipe applications other than automobiles

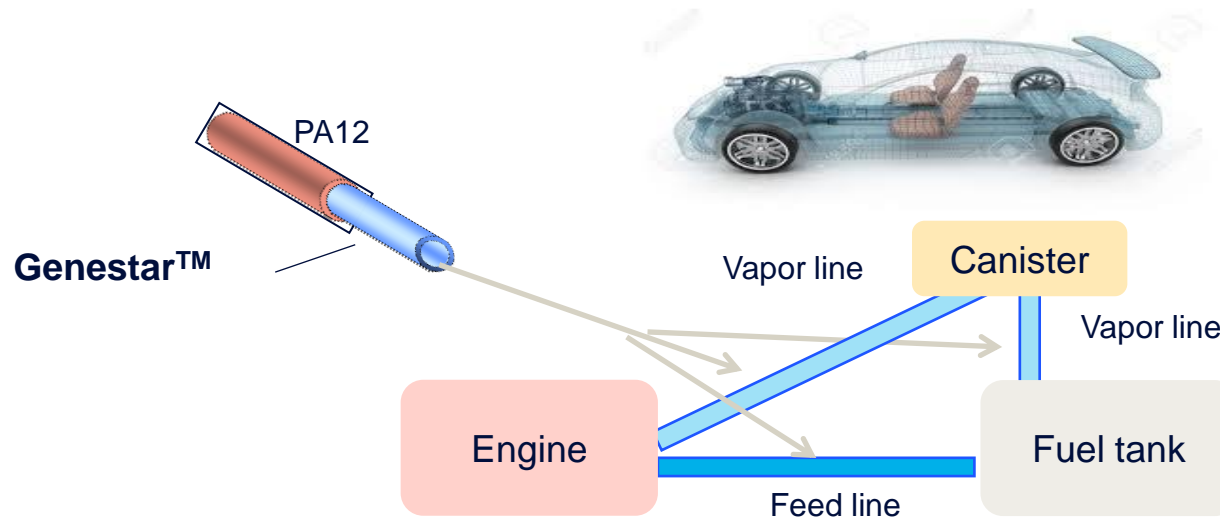

\*Oligomers  
A low molecular weight component of a polymer (macromolecule). In order to improve combustion efficiency, injectable fuels are increasingly atomized, and oligomers eluted from piping resin into fuel may cause clogging of injection holes.

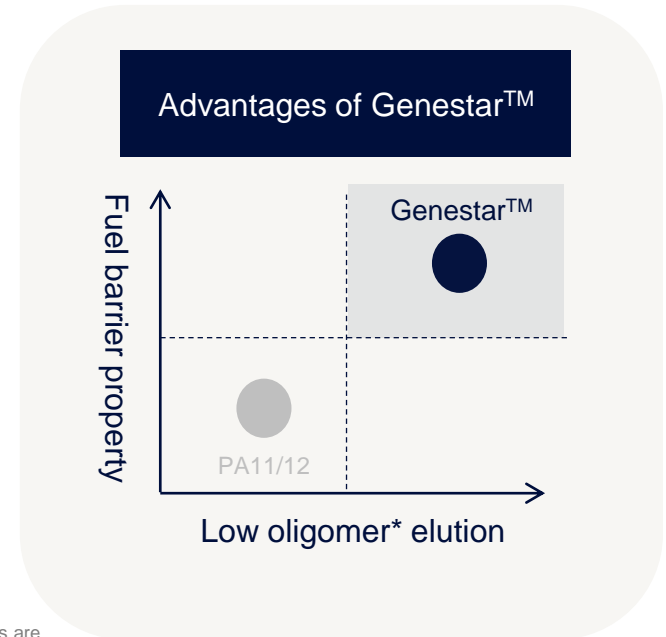

# Mobility④ Automobile Connectors

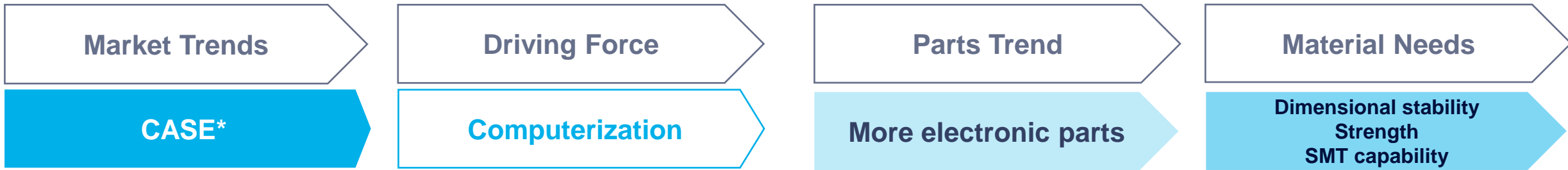

- Increased number of electrical components due to progress in automotive CASE
- SMT for automotive electrical components saves space, reduces size, and improves productivity
- The dimensional stability and strength of Genestar™ have been highly appreciated and its adoption has expanded

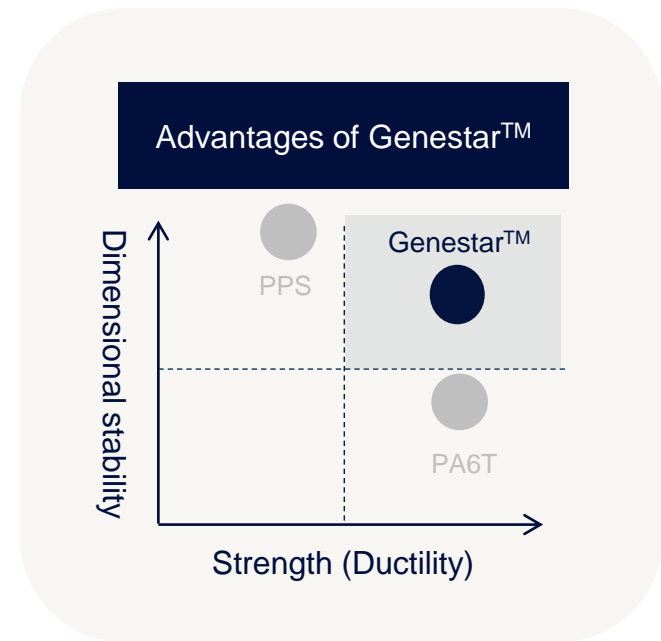
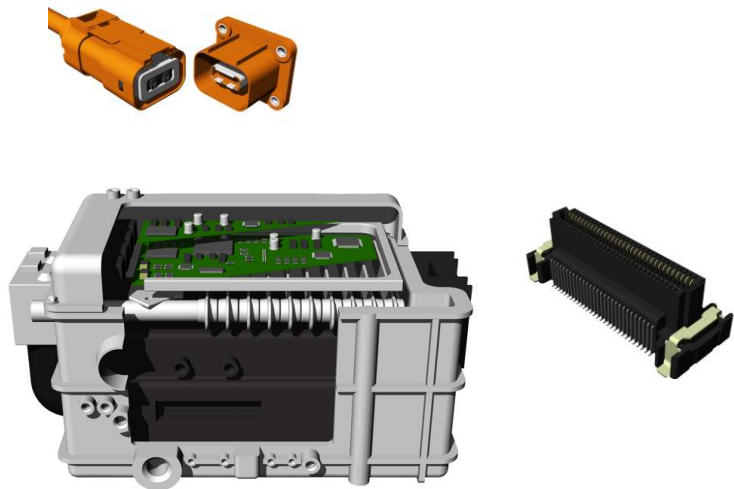

\*CASE : Connected, Autonomous, Shared, and Electric



# Mobility ⑤ High-voltage components (EV)

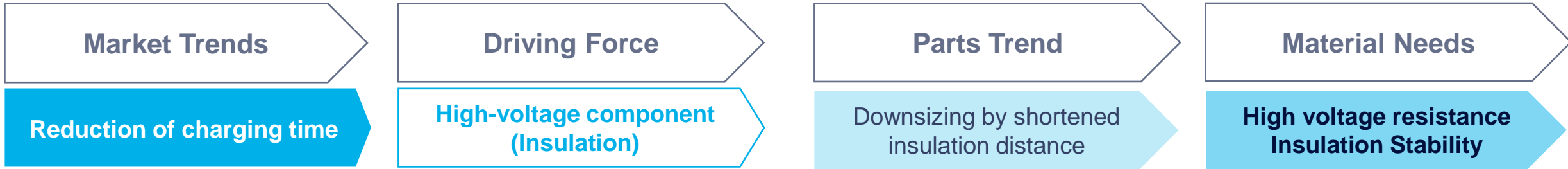

- To reduce **charging time (fast charging)**, EVs will increasingly adopt high-voltage systems of 800V or more.
- Increasing needs for materials with **high voltage (tracking) resistance** for high-voltage components for safety and miniaturization
- **The high-voltage resistance and low water-absorption properties of Genestar™** provides stable insulation enable downsizing of parts, broadening its application.

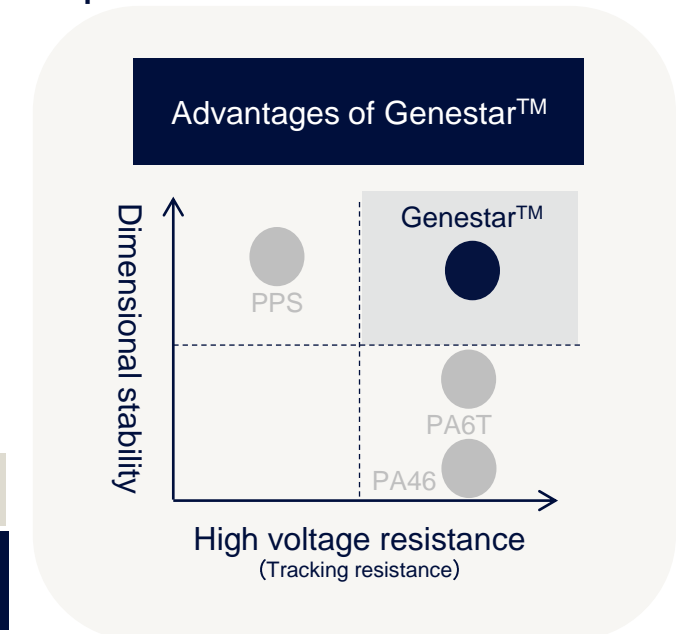
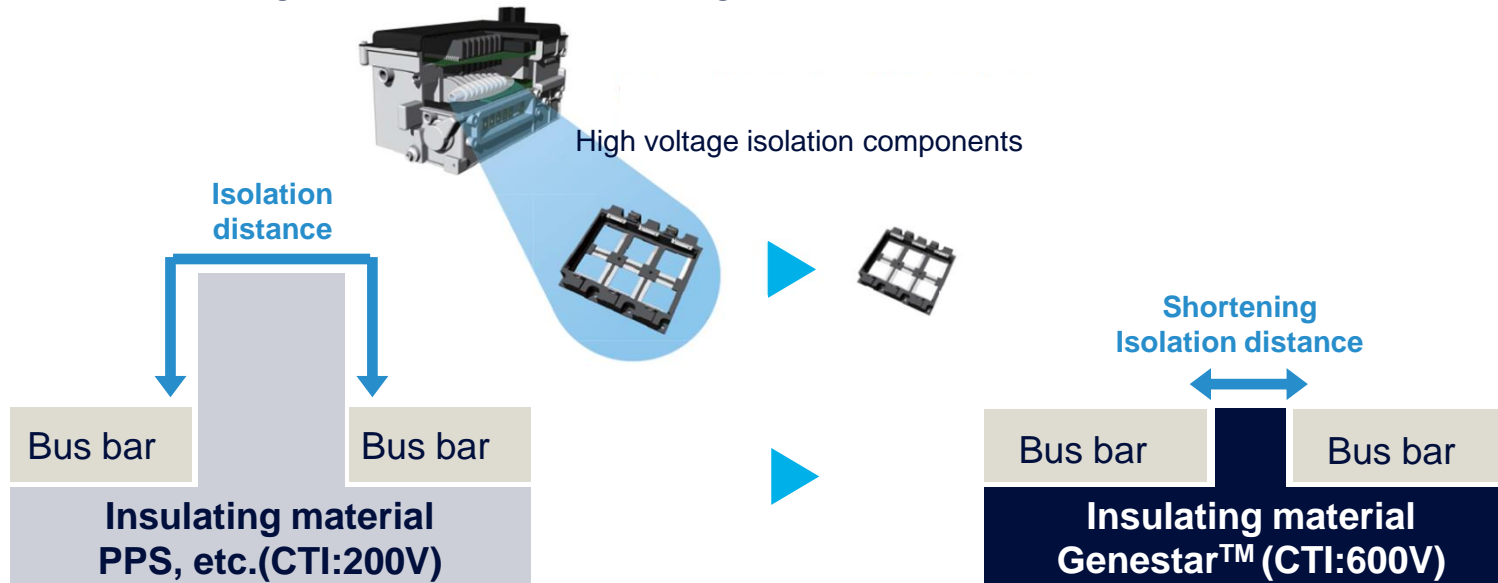

# Electrical and electronics Connectors for servers



- Demand for servers is growing rapidly due to high-speed, large-capacity communications (e.g., 5G communications) and support for generative AI.
- Connectors for servers standardized with SMT, thus high heat resistance is essential
- The dimensional stability (low water absorption) and strength of Genestar™ are highly appreciated and became de facto



Servers Connectors  
(DDR connector)

※DDR : Double-Data-Rate

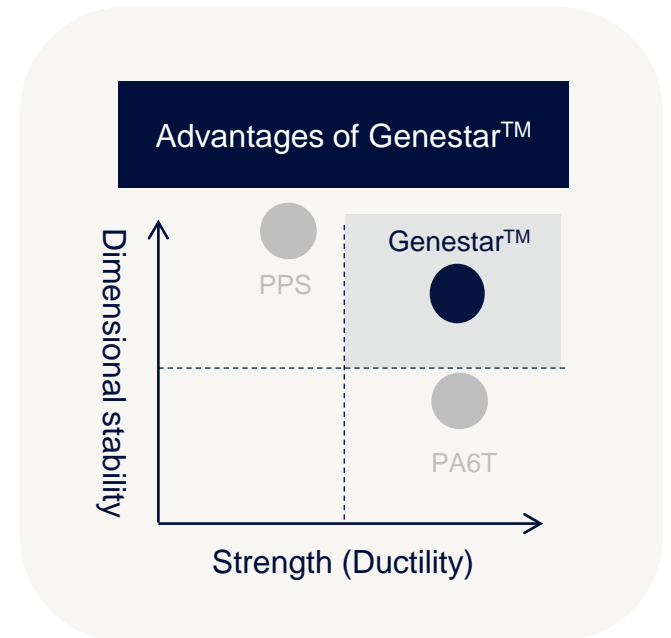

## Market Trends

Advanced, Multifunctional Industrial Equipment

## Driving Force

Higher output of power modules

## Parts Trend

High current Miniaturization

## Material Needs

High voltage resistance Insulation Stability

- Increasing power modules due to advancement and multifunctionalization of industrial equipment (electric railway, wind power generation, etc.)
- Expanding needs for high-voltage resistance (tracking resistance) materials to save space
- The high-voltage resistance and low water-absorption properties of the Genestar™ enable downsizing of parts and increasing adoption



High voltage isolation components (Power module case)

## Advantages of Genestar™

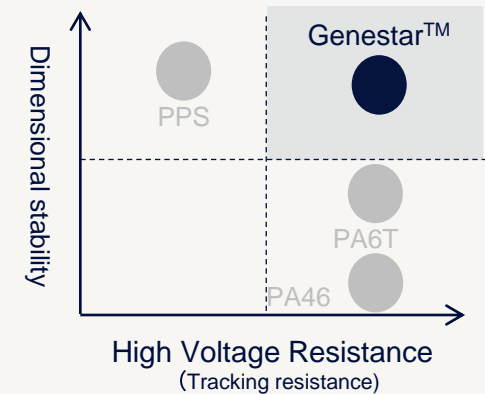

# Future Development of Genestar Business

## Growth Forecast\* of Genestar Business

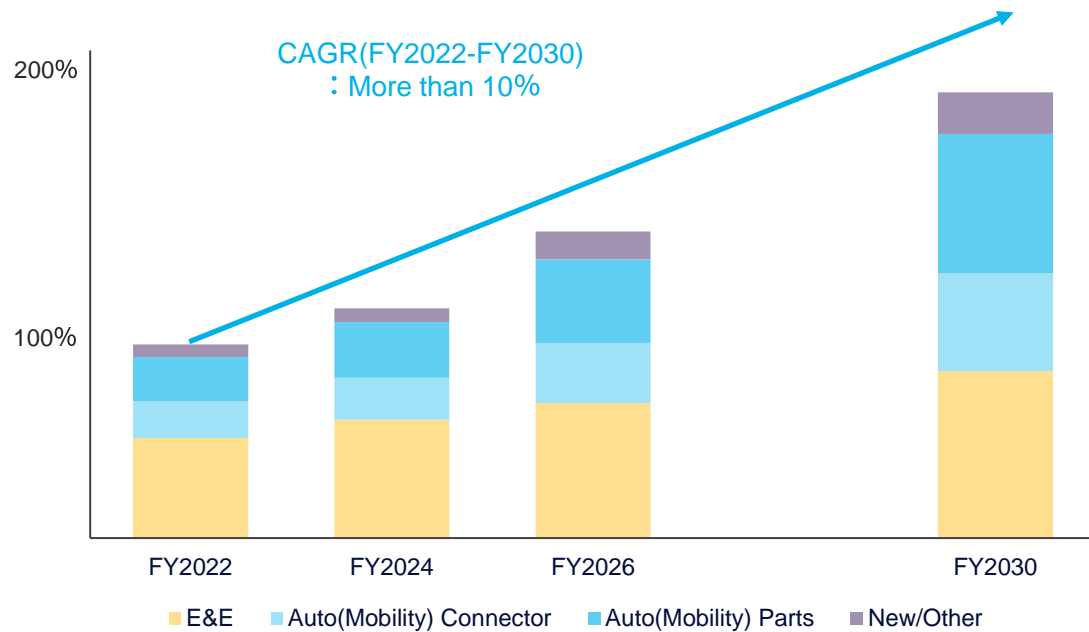

\*Image of sales volume expansion with FY2022 as 100%

**Achieved CAGR of 10% (FY 2022-2024)**  
**Continued 10% growth is expected**

- Increased adoption of auto parts due to weight reduction, electronic control, and electrification(EV)
- Further expansion into global markets including EU, US, and Asia
- Consideration of second phase expansion of Thailand plant

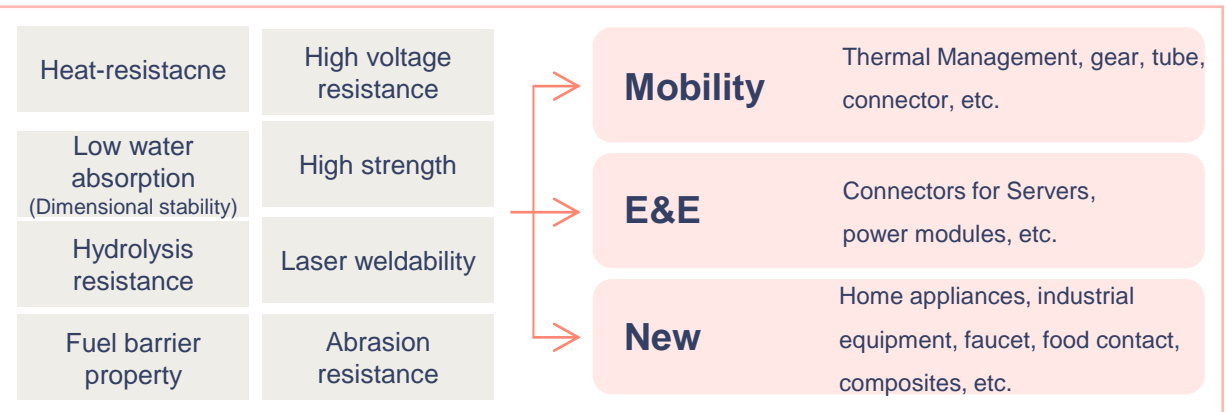

# kuraray

- 
- All figures are rounded to the nearest hundred million yen
  - The performance forecasts, outlooks, and business plans described in this document are based on current assumptions and estimates regarding future business environments and economic conditions. Please be aware that actual performance may differ from these projections.